



F&F Filipowski L.P.
Konstantynowska 79/81, 95-200 Pabianice, POLAND
phone/fax (+48 42) 215 23 83 / (+48 42) 227 09 71
www.fif.com.pl; e-mail: biuro@fif.com.pl

DR-30M

Motion sensor (PIR),
detection range 30 m



519024311674896

Do not dispose of this device in the trash along with other waste!

According to the Law on Waste, electro coming from households free of charge and can give any amount to up to that end point of collection, as well as to store the occasion of the purchase of new equipment (in accordance with the principle of old-for-new, regardless of brand). Electro thrown in the trash or abandoned in nature, pose a threat to the environment and human health.



Purpose

The DR-30M sensor is used for automatic, temporary switching of lighting when a moving person or other object is detected. It is especially recommended for use in high rooms and storage halls up to 12÷15 meters high.

Functioning

The sensor detects sources of infrared radiation and analyzing parameters such as the amount of heat emitted and the speed at which the object moves determines the switching of the lighting. Infrared sensors have the highest performance when detecting motion perpendicular to the sensor axis and the lowest when motion is directly in the direction of the sensor. Only if there is no movement in the detection area triggers the lighting support time. Another movement in the detection area and its subsequent disappearance in the course of time measurement starts the support time from the beginning.

Thanks to the advanced digital signal processing technology, the DR-30M is capable of detecting movement at distances up to 30 m (wall mounting) and in a circle with a diameter of 20 m in the case of ceiling mounting (mounting height 15 m). The motion sensor has a built-in programmable twilight switch that prevents the lighting from being switched on during the day. The maximum detection range and the lighting switching time are also programmable.



High temperatures may adversely affect the sensitivity of the device. Also, movement that is too slow or fast can limit the sensitivity of the sensor.

Diagram

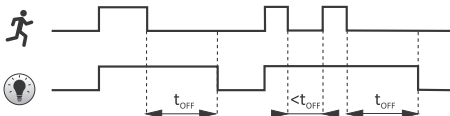

The heat emitted by a motion sensor-controlled light source can lead to accidental self-excitation of the sensor. Therefore, the sensor should be mounted at a reasonable distance from the light source (min. 60÷100 cm) and in such a way that the light source is outside the detection area of the sensor.

Sensor description

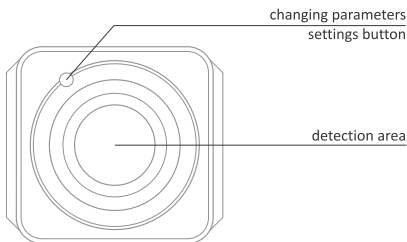

Configuration

The DR-30M sensor is supplied with the following settings:

- » the brightness level below which switching can occur: (50 lx),
- » switch-on time: 6 min.
- » detection range: 30 min.

Press and hold the change settings button to enter the sensor settings mode. The number of blinks of the signal light indicates the currently selected setting:

- » first blink: switch-on time;
- » second blink: brightness level (twilight switch);
- » third blink: detection range.

Release the button when the expected setting is indicated. Then set the desired value with short presses of the button.



If the button is not pressed for 5 seconds, the signal light will flash twice quickly, after which the current setting will be saved and the sensor will exit configuration mode.

Switch-on time settings

Without pressing a button	10 seconds
1 press	30 seconds
2 presses	1 minute
3 presses	2 minutes
4 presses	6 minutes
5 presses	10 minutes
6 presses	20 minutes (last setting – the indicator light will flash twice quickly, the setting will be saved and the detector will exit the configuration mode)

Brightness level setting¹

Without pressing a button	<10 lx
1 press	50 lx
2 presses	150 lx
3 presses	2000 lx (last setting – the indicator light will flash twice quickly, the setting will be saved and the detector will exit the configuration mode)

Detection range setting²

Without pressing a button	10 m
1 press	15 m
2 presses	20 m
3 presses	30 m max (last setting – the indicator light will flash twice quickly, the setting will be saved and the detector will exit the configuration mode)

1 The sensor will switch on the lighting if the brightness level measured by it is lower than the value set here.

2 The range setting is for wall mounting only and is indicative. The actual value will depend on the installation method and ambient temperature, among other factors. The detection range for ceiling mounting depends on the installation height, according to the figure on page 6.

Detection area

[m]

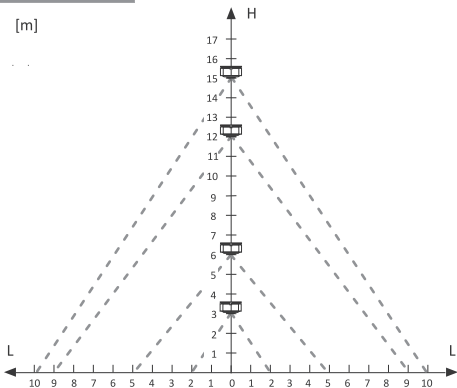

Ceiling mounting

Mounting height

Detection range (diameter)

3 m

4 m

6 m

10 m

12 m

18 m

15 m

20 m

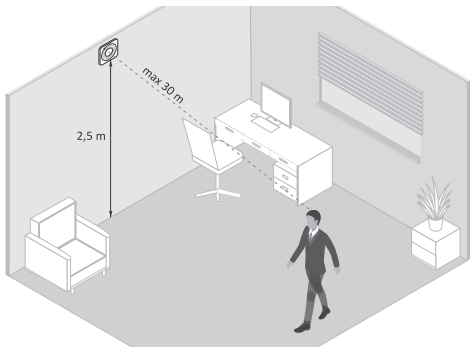

Wall mounting

Dimensions

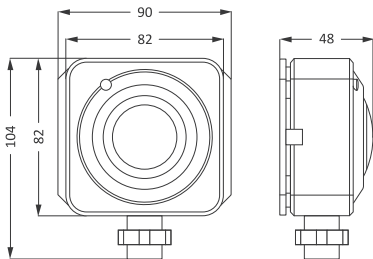

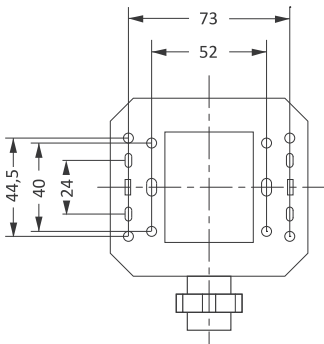

Mounting

1. Disconnect the power supply.
2. Remove the external (back) sensor cover.
3. Connect the wires according to the wiring diagram.
4. Fasten the base to the floor with two screws.
5. Assemble the sensor housing - push on the outer cover.
6. Set the desired parameters.
7. Switch on the sensor power supply.



If the motion sensor is installed too close to the switched light source, the system may be activated, which means that the sensor will automatically switch on and off the light source. It is necessary to move the sensor to an appropriate distance away from the light source.



The sensor is inactive for the first 30 seconds after the power supply is switched on. During this time, the PIR system warms up.



The motion sensor can work indoors and outdoors in places where it is not exposed to direct rain or snowfall and to the possibility of splashing the sensor housing and its electrical connection points with water or other liquid.



Avoid locations with large objects in the detection area such as trees that can be moved by the wind.



Do not install the sensor in the immediate vicinity of heating, air-conditioning and lighting devices.

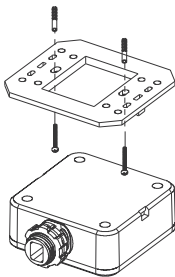

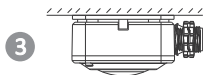
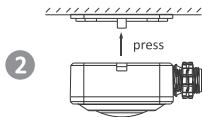
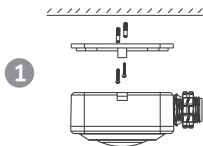

Ceiling mounting

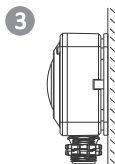
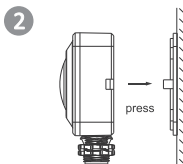
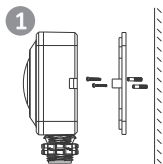

Wall mounting

Wiring diagram

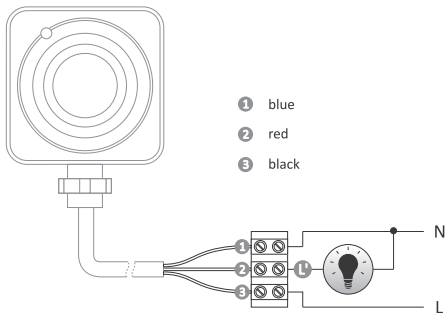

Technical data

power supply	100÷277 V AC
maximum load current (AC-1)	16 A*
maximum load	
continuous	2300 W
momentary	3000 W
twilight activation threshold	10÷2000 lx
motion detection	0.6÷1.5 m/s
switch-on time	30 s÷20 min. (±10 s)
detection angle	80°
max detection range (T<22°C)	
ceiling mounting	diameter 20 m
wall mounting	30 m
sensor mounting height	
ceiling mounting	3÷15 m
wall mounting	2÷3 m
power consumption	
standby	0.45 W
on	1 W
terminal	1.5 mm ² screw terminals
tightening torque	0.3 Nm
working temperature	-10÷40°C

* Load of a resistive nature [AC-1].

For loads of a different nature (e.g. LED lighting), the maximum load current may be significantly lower.

More information:

www.fif.com.pl/en/content/24-wskazowki



dimensions	
housing	90×82 mm, h= 48 mm
housing with handle	90×104 mm, h= 48 mm
mounting	surface
ingress protection	IP40

If it is necessary to control a load with parameters exceeding the limit load capacity of the relay, one of the following solutions should be used:



- » limitation of the inrush current using a soft-start system (for example MST-01, MST-02, MST-03 – all manufactured by F&F,
 - » use of an auxiliary contactor (e.g. ST25 by F&F).
-

Warranty

The F&F products are covered by a warranty of the 24 months from the date of purchase. Effective only with proof of purchase. Contact your dealer or directly with us.

CE declaration

F&F Filipowski L.P. declares that the device is in conformity with the essential requirements of The Low Voltage Directive (LVD) 2014/35/EU and the Electromagnetic Compatibility (EMC) Directive 2014/30/UE.

The CE Declaration of Conformity, along with the references to the standards in relation to which conformity is declared, can be found at www.fif.com.pl on the product page.

