



F&F Filipowski sp. j.
 Konstytucyjna 79/81 95-200 Pabianice
 tel/fax +48 42 2152383; 2270971 POLAND
 http://www.fif.com.pl e-mail: fif@fif.com.pl

**DIGITAL TEMPERATURE
 REGULATOR**

CRT-06

WARRANTY. The F&F products are covered by the 24 months warranty from date of purchase. Effective only with proof of purchase. Contact your dealer or directly from us. For more information on the procedures for filing complaints on www.fif.com.pl/reklamacje



CE Do not dispose of this device in the trash along with other waste! According to the Law on Waste, electro coming from households free of charge and can give any amount to up to that end point of collection, as well as to store the occasion of the purchase of new equipment (in accordance with the principle of old-for-new, regardless of brand). Electro thrown in the trash or abandoned in nature, pose a threat to the environment and human health.

PURPOSE

The CRT-06 controller is multi-function, programmable electronic devices which enable control of heating or cooling devices in order to maintain a stable room temperature, as well as to control ambient and substance temperatures in industrial conditions, with the option of supervising technological processes.

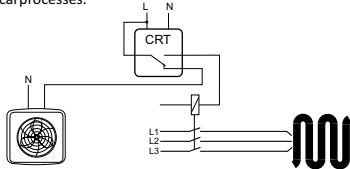

- CRT-06 is equipped to:
- controlling panel use for programming and monitor to work of regulator
 - possibility of connection two independent temperature probes PT-100
 - two outputs of relay 1P which were attribute to sensors

In standard work mode on display are present values of temperaturer which are measure by sensors C1 and C2. If is connect only one sensors- C1, then at place on display for reprints from C2 anything is displaid.

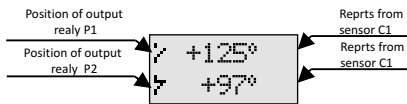

Signs on the left side of display, signalize work mode of regulator in position of output relay. This sign present:

	Open joint - automatic work mode
	Close joint - automatic work mode
	Open joint - manual work mode
	Close joint - manula work mode

Buttons functions:

	In programming mode button Return make possible to return main menu. If button will be push at edition mode, then program return to main menu without save all registry. Button Return enable to delete information about errors.
	At programming mode buttons UP and DOWN make to possibility to select position of menu and to increase or reduce value of edited parameter.

CONTROLLERS FEATURES:

- control panel for programming and monitoring;
- 10 operation functions;
- 2 independent temperature sensors;
- two independent temperature values may be set;
- 2 x 1P contacts applied to the temperature sensors;
- 2 hysteresis set values, one for each sensor;
- AUTOMATIC mode - operation with one selected function;
- MANUAL mode permanent closing or opening of the contact without a temperature measurement. Separate temperature drops for the P1 and P2 contacts.
- memory feature for maximum and minimum temperature values registered, independent for the C1 and C2 sensors;
- CORRECTION related to the temperature read-out error against the model thermometer;
- WARNING - visual signalisation of the temperature sensor failure, range exceed and speed rising or falling temperature exceed
- limiting access to program menu using PIN code
- LIGHT selection of display illumination mode.
- LANGUAGE program menu in three languages: Polish, English or Russian

DESCRIPTION OF CONTROL PANEL:

To work and programming of regulator CRT-06 use control panel. It include two line with eight sign on alfanumerical display and keyboard with five buttons, which is situated under the display.

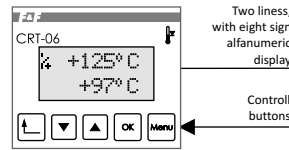

	In programming system mode button OK enable to pass to selected position from menu and enter the changes. In standard work button OK is use to change order temperature T1 and T2.
	Button Menu enable to pass to programming mode of regulator. In change order value mode use it cause reconnection between setting for first and secon sensor.

PROGRAMMING

Pass to programming mode is possible by push button MENU.

Structure of main menu:

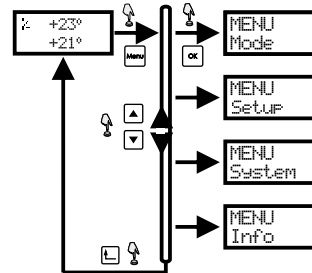

To select position from menu we use buttons "UP" and "DOWN". If you want pass to selected position then you need push button OK. Pass to main menu is possible by push button return.

Menu -> MODE

This mode is use to set mode of work: automatic or handwork. In automatic work position of output relay is depend of reprts from sensors which are connect to regulator and executed program. Hadwork mode make possibility set of output relays independent of reports from sensors.

Instruction to select work mode :

1. By button Menu pass to main menu.
2. Prees button OK, to entered pass to menu.
3. By buttons "UP" or "DOWN" select work mode: MANUAL or AUTO, enter by OK.
4. If will choosen hadnwork mode, wil dispalied additional menu to set position outout of relay (open or close). Select by buttons "UP" or "DOWN" and enter by OK. Pass to main menu without save all settings is possible by push button return.

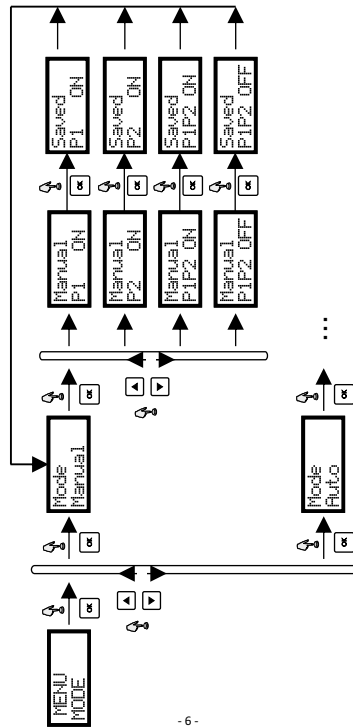

ATTENTION!

Choose handwork mode is signalize by sign R near sings which present position of relays.

Handwork P1 ON	P1 ON - joint of relay P1 is close, but joint of relay P2 is open.
Handwork P1 OFF	P2 ON - joint of relay P1 is open, but joint of relay P2 is close.
Handwork P1P2 ON	P1P2 ON - joints of relays P1 and P2 are close.
Handwork P1P2 OFF	P1P2 OFF - joints of relays P1 and P2 are open.

5. In automatic work will dispalied menu to select program (one of tenth) saved in device memory.

By buttons "UP" or "DOWN" choose program (option to use are present under) and enter by button OK. Possible is return to main menu without save all changes by push button return.

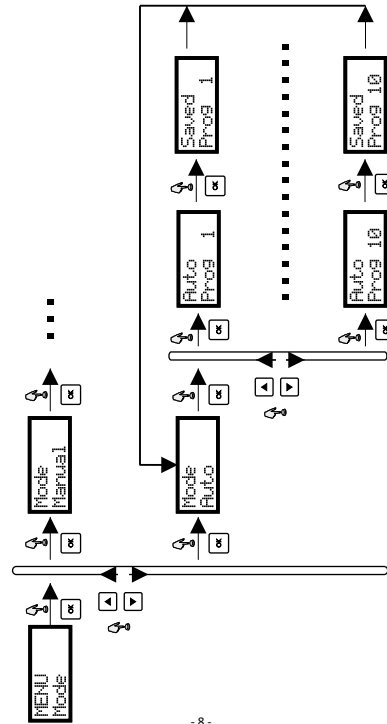

PROG 1 WARMING mode

Regulator work with sensor C1 which have defined temperature T1 and hysteresis H1.

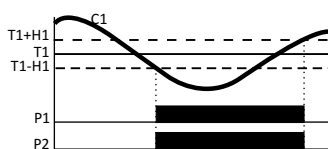

If temperature on output relay C1 fall under value (T1+H1), it cause close a joint P1 and P2 in the same time. Joints P1 and P2 will be open if temperature on input sensor C1 cross value (T1+H1).

PROG 2 COOLING mode

Regulator work with sensor C1 which have defined temperature T1 and hysteresis H1.

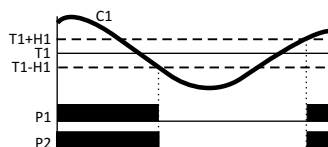

Relays P1 and P2 work in parallel connection and closing joints when temperature is higher than value(T1+H1). Joints of relays will be open when temperature fall under value (T1-H1).

If temperature of sensor C1 fall under value (T1-H1), it caue close a joint P1. When temperature increase higher than value (T1+H1), than joint P1 will be returnly open. Similary for sensor C2 when temperature will be smaller than (T2-H2) than joint P2 will be close, returnly opening will be possible than temperature cross value (T2+H2).

PROG 5 COOLING mode- two regulators

Regulator works with sensors C1 and C2 in function two independent thermostat which works in cooling mode. For sensor C1 is defined temperature T1 and hysteresis threshold H1, but for sensor C2 is defined temperature T2 and hysteresis threshold H2.

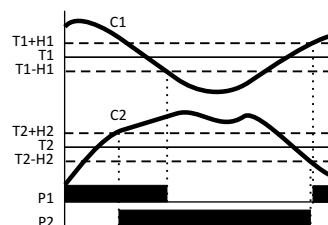

If temperature from sensor C1 increase higher than value (T1 + H1), then joint P1 will be closed. But when temperature fall under value (T1 - H1), than joint P1 will be returnly open. Similary for sensor C2, when temperature will be higher than value (T2 + H2) than joint P2 will be closed. It will be returnly open when temperature fall under value (T2 - H2).

PROG 3 WARMING/COOLING mode

Regulator work with sensor C1 which have defined temperature T1 and hysteresis threshold H1.

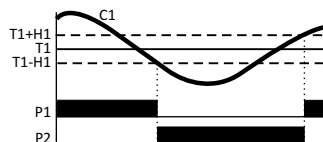

Relays P1 and P2 works alternately. P1 work in cooling mode, closing joint when teperature fall under value (T1 - H1) and opening it when cross value (T1 + H1). Realy P2 work in heating mode, closing joint when temperature fall under value (T1 - H1) and returnly opening it when cross value (T1 + H1).

PROG 4 WARMING mode- two regulators

Regulator works with sensors C1 i C2 in function two independent thermostat which works in heating mode. For sensor C1 is defined temperature T1 and hysteresis threshold H1, but for sensor C2 is defined temperature T2 and hysteresis threshold H2.

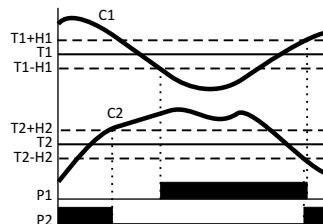

PROG 6 WARMING mode- two regulators.

Second regulator dependent from first regulator.

Regulator work wigt two sensors C1 and C2, whiches have defined temperature T1 and T2, and hysteresis thresholds H1 i H2.

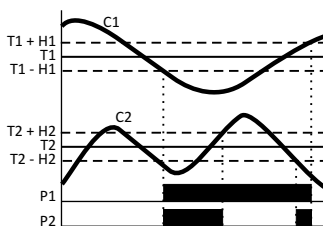

The first thermostat, is connect with sensor C1, it close when temerature from relay and output fall under value (T1-H1) and open it when cross value (T1+H1). Position of the second thermostat, which is connect with sensor C2 and outpu P2, depend from position of the first thermostat and temerature from sensor C2. Joint P2 will be closed when temperature from sensor C2 will be smaller than value (T2-H2) and joint P1 will be closed. Condition for open joint P2 is crossing by sensor C2 value (T2+H2) or open joint P1.

PROG 7 Differential regulator

Regulator work with two sensors C1 and C2. Ordered parameter is distinction of temperatures. If distinction between reprints from the first and second sensors (C1 C2) cross ordered value then will be closed joint P1. If distinction of temperatures will be smaller than ordered value then joint P2 will be close.

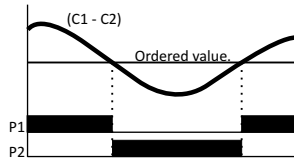

PROG 8 Window mode (one sensor)

Regulator work with sesor which is connect to joint C1. If temperature from sesor will be in range defined by values T1 and T2, then realys joints P1 and P2 will be closed.

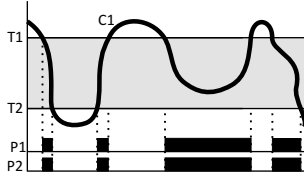

ATTENTION: When will set value $T2 > T1$ then regulator will be work correct.

PROG 9 Window mode (two sensors)

Regulator works with two sesors C1 and C2. If temperature from two sesors will be in range, which is defined by values T1 and T2, then relay joints P1 and P2 will be closed.

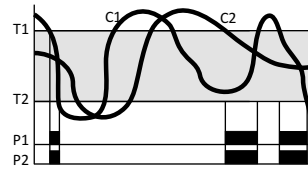

ATTENTION: When will be set value $T2 > T1$ then regulator will be work correct.

PROG 10 Window mode - two regulators

Device works as two independent thermostats, which works in window mode. Sensor Czujnik C1 dependent from parameters s T1 and T2 and steer output of relay P1. Sensor C2 dependent from parameters T3 and T4 i, steer output of relay P2.

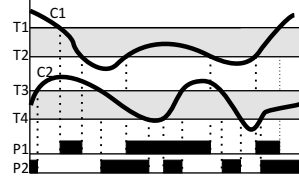

If temperature from sensor C1 will be included in range between values T1 and T2, then joint of realy P1 will be close. Similary if temperature from sensor C2 will be included in range between values T3 and T4, then joint of relay P2 will be close.

ATTENTION: When temerature will $T2 > T1$, or $T4 > T3$, then regulator doesn't

Menu -> SETTINGS

This menu is use to configuration parameters of regulator in automatic work. If you need edit parameters follow with procedure:

1. By button Menu pass to main menu.
2. By buttons "UP" or "DOWN" select menu Menu -> Settings and enter OK..
3. By buttons "UP" or "DOWN" select parameter to edition and prees OK...
4. By buttons "UP" or "DOWN" set value of parameter and enter by OK..
5. Entered of change is signalize by raport: Saved with value of saving parameter.
6. Possible is out from edition mode to main menu without save all changes by button return.

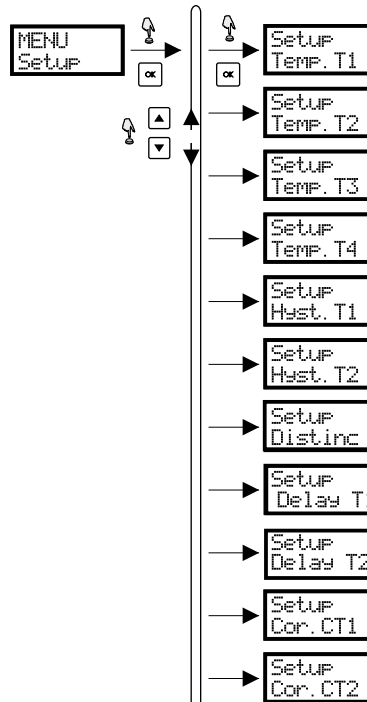

Example of change parameter value.

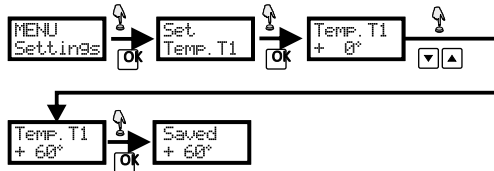

ATTENTION: Edition of setting is possible for parameter which are use in a executigram. When need to change parameter which isn't use in program then option will not table.

ATTENTION: Settings which were able to program, are present under (numbers aren't cross out):

	1	2	3	4	5	6	8	9	10	
Settings Temp.T1	Ordered value of temperature T1 Temperature could be set in range: -100÷400°C with precision 0,5°C. ATTENTION!!: Possible is quick change value of ordered temperature T1 and T2 without pass to menu-> settings. You need in standard work push button OK. It cause display actual value. Next by buttons "UP" or "DOWN" set new value and enter by OK. If need edit next temperature push button OK. Push a button return cause out from edition mode without save all changes.									

Settings Temp.T2	Ordered value of temperature T2. Temperature could be set in range -100÷400°C with precision 0,5°C.									
Settings Temp.T3	Ordered value of temperature T3. Temperature could be set in range -100÷400°C with precision 0,5°C.									
Settings Temp.T4	Ordered value of temperature T4. Temperature could be set in range -100÷400°C with precision 0,5°C.									
Settings Hyst.T1	1	2	3	4	5	6	8	9	10	
Settings Hyst.T1	Value of hysteresis for temperature T1. Temperature could be set in range 1÷100°C with precision 0,1°C.									
Settings Hyst.T2	Value of hysteresis for temperature T2. Temperature could be set in range 1÷100°C with precision 0,1°C.									
Settings Distiction	Ordered distiction of temeratures which is use as parameter prog 7. Distiction of temperatur could be set in range 1÷500°C with precision 0,1°C.									

	1	2	3	4	5	6	8	9	10	
Settings Delay T1	Minimal time to execute one cycle of program (ON or OFF) Parameter DelayT1 is dependent from sensor C1. Example of work for prog 1 with delay. Delay is present on under picture.. 									
Settings Delay T2	Minimal time to hold a one position (ON or OFF) of relay output Parameter DelayT2 is dependent from sensor C2. Example of work for prog 1 with delay. Delay was present in earlier point.									
Settings Cor.C1	Correction of sensor reports C1. Sensor reprints could be corrected by ±20°C with precision 0,1°C.									

	4	5	6	7	8	9	10
Settings Cor.C2	Correction of sensor reports C2. Sensor reprints could be corrected by ±20°C with precision 0,1°C.						

Menu -> System

This menu is use to set settings which were left, independt of work mode and executing program.

1. By button Menu pass to main menu.
2. By buttons "UP" or "DOWN" select menu Menu-> Settings and enter OK.
3. By buttons "UP" or "DOWN" select option (one of sevenf) and enter by OK.

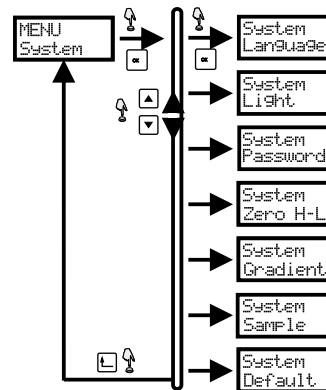

4. **System->Language.** This parameter make possibility to choose on of three language in which will be display reports. If you need change language you need pass to menu System -> Language by buttons "UP" or "DOWN" select language and enter by button OK. Return to main menu is possible by push button return.

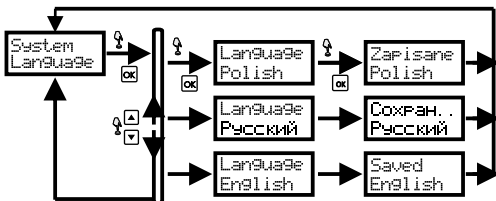

5. **System->Light.** This parameter make possibility to lighting a display of regulator. Possible is set lighting for all the time for display or lighting only for some second after push any button

If you need way of lighting you need to pass menu System -> Light and select by buttons "UP" or "DOWN" correct option and enter by button OK.. Return to main menu is possible by push button Return.

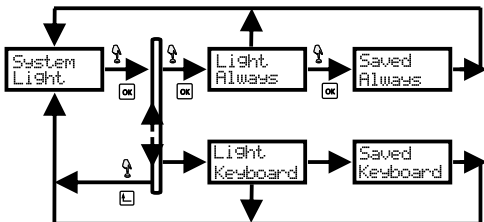

PIN code is entered only once for all time to edit parameters from edition mode. After out from edition mode regulator stay in unlock position about 10sec, (it is signalize by blinking key sign in display). At this time could return to edition mode (button MENU) without key PIN code.

ATTENTION: In safe mode possible is quick change ordered temperature T1 and T2 (press button OK in standard work).

7. **System -> Zero H-L.** This mode is use to delete min and max temperature (which could be read from Menu->Info) registered by sensor. In cause to delete min and max value of temperature need pass to menu System -> Zero H-L and enter by OK. Next by buttons "UP" or "DOWN" select value YES and enter by OK.

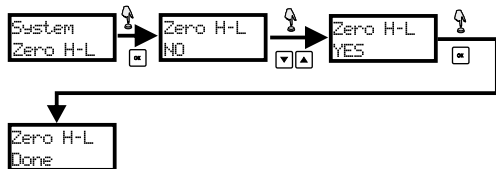

8. System -> Average

Parameter Average specifies the period of time which is calculated the average temperature. The parameter can be varied from 3 to 30 seconds. To change sample frequency need pass menu System -> Samples, by buttons "UP" or "DOWN" set frequency and enter by OK Return to main menu without save all changes is possible by button return.

6. **System-> Password.** This parameter is use to safe acces for all user to menu. Password is a number from range 0 to 999, but save password to 0 unlock a menu. Set password another than 0, cause pass timer to safe mode. In cause change of PIN need to pass menu System -> Language and by buttons "UP" or "DOWN" set the first digit of PIN code. Push a button Menu cause pass to edit the next digit of PIN code. After set all PIN enter by button OK. Possible is out from edition PIN code mode without save changes by button return.

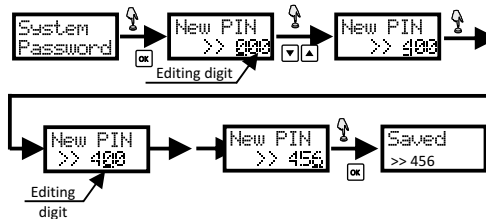

ATTENTION:

Work in safe mode is signalize by dispialed a sign . In this use pass to setting of regulator (press button MENU) is previous by key correct a pin code.

Example of key PIN code:

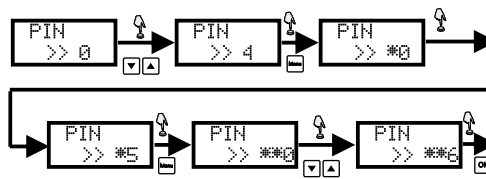

- 22 -

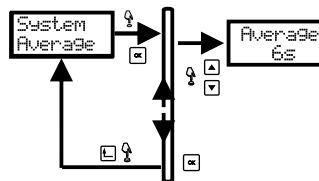

After starting the controller for the time-setting as average driver waits for fill the data buffer. During this time, the automatic programs are not implemented, and the display shows "collect data".

9. **System-> Default.** Default settings make possibility to return all settings of regulator to target values. If you need restore default settings pass to menu System -> default settings and enter by button OK. Next by buttons "UP" or "DOWN" set value YES and push button OK.

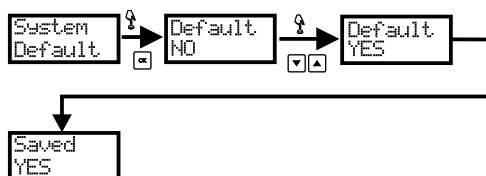

ATTENTION!

Return to default settings cause delete all earlier configurations with saved programs.

- 23 -

- 24 -

Rest of parameters of regulators are set with values:

Mode	Manual
T1	0,0°C
T2	0,0°C
T3	0,0°C
T4	0,0°C
H1	0,0°C
H2	0,0°C
Delay to C1	0min
Dealy to C2	0min
Sensor correction C1	0,0°C
Sensor correction C2	0,0°C
Distinction	0,0°C
Password	Lack
Light	All time
Gradient	OFF
Sampling	30 samples/min
Language	poliash

Menu -> Info

This Menu -> Info is use to display max and min values which were registered by temperature sensor.

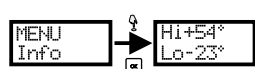

- 25 -

Error codes

Wrong work of regulator is signalize by blinkig display illumination and dispaly error number code. Delete information aboot error (if break will be fixe) possible is by push button return.

Explain of error codes::

Error Code :01	Cross acceptable range for reports from sensor C1. Lack or break sensor C1.
Error Code :02	Cross acceptable speed change temperature value for sensor C1.
Error Code :03	Cross acceptable speed change temperature value for sensor C2.
Error Code :04	Cross acceptable range for reports from sensor C2. Lack or break sensor C2. (only for pprograms which use sensor C2 .

- 26 -

WIRING DIAGRAM

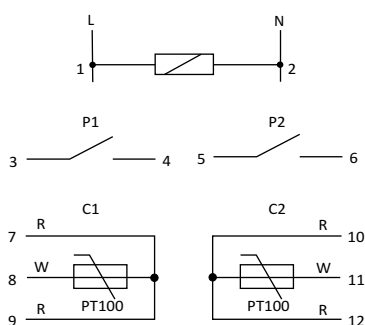

ASSEMBLY:

1. Take OFF the power.
2. Regulator put on the rail in the switchgearbox.
3. Connect supply: L to joint 1; N to joint 2.
4. Out cable of probe of temperature C1 connect to joints 7-8-9.
5. Out cable of probe of temperature C2 connect to joints 10-11-12.
6. System which enclose receiver is dependent from sensor C1 connect in line to joints 3-4 (P1).
7. System which enclose receiver is dependent from sensor C2 connect in line to joints 5-6 (P2).
8. Set program to regulation temperature.

- 27 -

TECHNICAL DATA

CRT-06

supply	230V AC
current load	2x(<16A)
joint	separated 1P
range of regulation temperature	-100÷400°C
hysteresis setting range	0÷100°C
precision	1°C
reconnection delay	0÷45min
model correction	±20°C
gradient	4°C /sec÷6°C/min.
sample frequency	1÷120 samples/min.
power consumption	1,5W
working temperature	-20÷40°C
terminal	screw terminals 2,5mm ²
dimensions	3 modules (52,5mm)
fixing	on rail TH-35

PROBE RT56

sensor	PT100
dimensions of sensor	∅4; h=85mm
sensor isolation	steel bush
cable	PC 3x0,34mm; l=1,5m



D131029/131206

- 28 -